

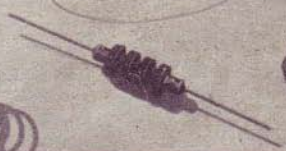

30P



EDDYSTONE

SHORT WAVE COMPONENTS

SEASON 1939

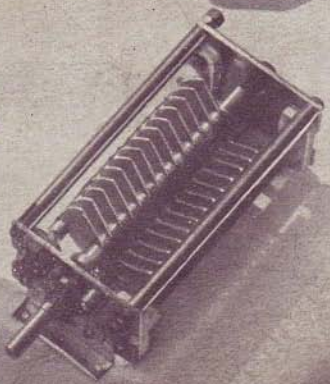
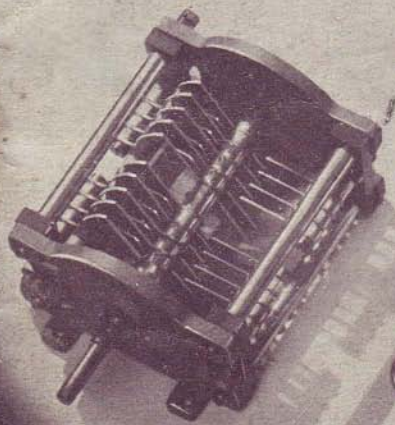
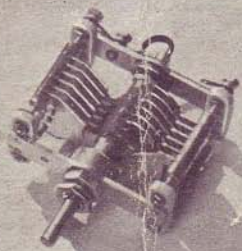
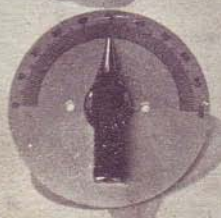

EDDYSTONE

Low Loss Interchangeable Coils

COVERING 9 METRES TO 2,000 METRES.

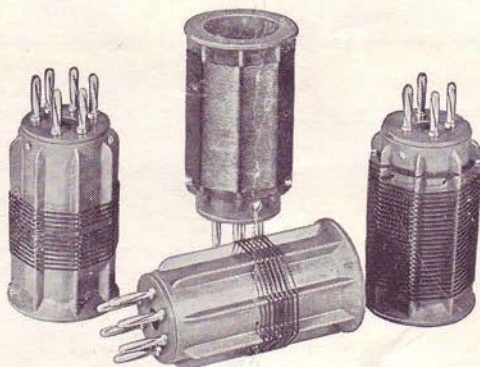

Our coils are of the highest efficiency, and first-grade workmanship. Using D.L.-9 high frequency formers, matched inductances, and H.C. enamelled wire. Helically slotted pins ensure full surface contact. Windings are soldered to pins, which are rivetted and cannot work loose. The approximate wave-ranges of the coils are for a 160 m.mfd. tuning condenser, and allow for average circuit load.

FOUR PIN TWO WINDING. CAT. No. 932.

WINDING TURNS AND INDUCTANCES.

Type	Metres	Primary	Grid	Inductance	Code	PRICE
BB	9-14	3	2 $\frac{3}{8}$	0.50 μ H.	ACBB	2/9
LB	12-26	2	3 $\frac{3}{8}$	1.08 μ H.	ACBE	2/9
Y	22-47	4 $\frac{1}{8}$	8 $\frac{3}{8}$	3.62 μ H.	ACYE	2/9
R	41-94	9 $\frac{3}{8}$	23 $\frac{3}{8}$	14.24 μ H.	ACRO	2/9
W	76-170	15	35	45.0 μ H.	ACWO	3/3
P	150-325	25	92	0.188 mH.	ACPI	3/6
G	260-510	40	138	0.420 mH.	ACGO	3/6
BR	490-1000	30	315	1.90 mH.	ACBR	4/6
GY	1000-2000	140	630	6.98 mH.	ACGY	4/6

SIX PIN THREE WINDING. CAT. No. 959.

WINDING TURNS AND INDUCTANCES.

Type	Metres	Primary	Grid	Inductance	Reaction	Code	PRICE
6 BB	9-14	1 $\frac{1}{4}$	2 $\frac{3}{8}$	0.51 μ H.	3	EXBB	3/3
6 LB	12-26	2	3 $\frac{3}{8}$	1.07 μ H.	3	EXLIB	3/3
6 Y	22-47	4 $\frac{1}{8}$	8 $\frac{3}{8}$	3.62 μ H.	4 $\frac{1}{8}$	EXYEL	3/3
6 R	41-94	9 $\frac{1}{8}$	23 $\frac{3}{8}$	14.13 μ H.	9 $\frac{1}{8}$	EXRE	3/3
6 W	76-170	10	35	45.0 μ H.	14	EXWO	3/9
6 P	150-325	42	92	0.188 mH.	35	EXPI	4/6
6 G	260-510	90	138	0.428 mH.	40	EXGO	4/6
6 BR	490-1000	200	315	1.53 mH.	80	EXBRO	5/-
6 GY	1000-2000	300	630	7.05 mH.	140	EXDOY	5/-

SIX PIN COIL BASES FOR CAT. No. 959 COILS.

For above baseboard wiring. D.L.-9 insulation, low self capacity, one piece sockets, positive electrical contact.

CAT. No. 969.

Code ESAF.

PRICE .. **2/3**

For under baseboard wiring. D.L.-9 insulation with special ribs to reduce leakage between sockets.

CAT. No. 964.

Code ESAF.

PRICE .. **1/3**

The four-pin coils, Cat. No. 932, have standard valveholder fittings.—See page 10.



Ultra S.W. Interchangeable Coils

These coils are wound with 14 gauge high conductivity electrolytic copper wire and are heavily silver plated. The ends act as the actual plugs and the coil is mounted on a Frequentite strip. A separate Frequentite base with silver plated sockets provides easy and efficient coil changing. A 4 turn coil covers 4-6 metres combined with the 3 turn as aerial coupling. The 6 and 8 turn coils cover 6-8 and 8-10 metres combined with the 4 turn as coupling coil. The mean diameter of the coils is $\frac{3}{4}$ ".

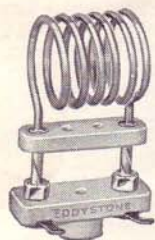

CAT. No. 1050.

3 turns	Inductance 0.10	μ H.	Code ULCO	PRICE 1/6
4 turns	Inductance 0.25	μ H.	Code ULCA	PRICE 1/6
5 turns	Inductance 0.38	μ H.	Code ULTI	PRICE 1/7
6 turns	Inductance 0.46	μ H.	Code ULTO	PRICE 1/8
8 turns	Inductance 0.77	μ H.	Code ULTA	PRICE 1/10

FREQUENTITE BASE FOR ABOVE. CAT. No. 1051. Code ULBA. PRICE 1/-

Split Stator Condensers

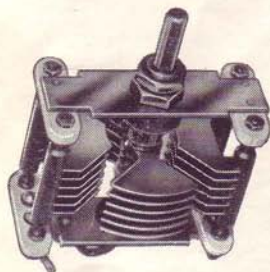

CAT. No. 1068.

Code STATR.

PRICE .. 12/6

This condenser will find many uses as the tuning element in short wave receivers, transmitters or wavemetres. It provides the choice of three different maximum capacities according to the way in which it is used. It is a solidly built component with heavy brass vanes with polished edges. All metallic connections are soldered to ensure minimum losses and a low high frequency resistance. Both sets of fixed vanes are supported on Frequentite Insulators while the back bearing of the rotor is insulated from the brass cross-member, the connection being made to it by a screened non-inductive pigtail. It is noiseless in use.

Minimum capacity formed by rotor, and one side is 5 m.mfd. and the maximum capacity 40 m.mfd. With the two sides in parallel, the minimum is 10 m.mfd. maximum 80 m.mfd. When used as a series-gap condenser minimum capacity is 3 m.mfd. and the maximum 20 m.mfd.

HIGH VOLTAGE TYPE

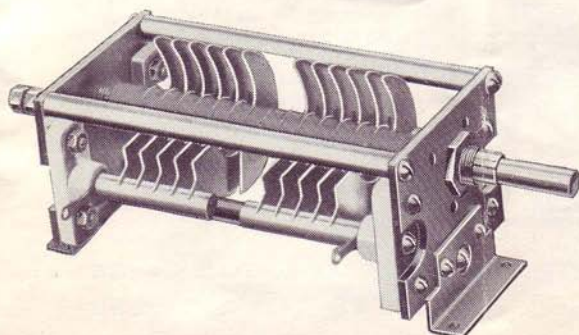

CAT. No: 1087.

Code SPLTR.

PRICE 15/-

For ultra short wave and short wave transmitters with inputs up to 150 watts. Rigid all brass construction, soldered vanes and Frequentite insulation. Fully supported bearings, dual mounting for panel or baseboard. Peak flashover voltage 3,500 volts. Capacity of each section 6-27 m.mfd. In parallel 12-54 m.mfd. In series 1-10.5 m.mfd. $\frac{1}{4}$ " spindle. Dimensions as No. 1083 (see page 3). Soldering tag or terminal connections.



Transmitting Condensers

3,500 PEAK VOLTAGE TYPE

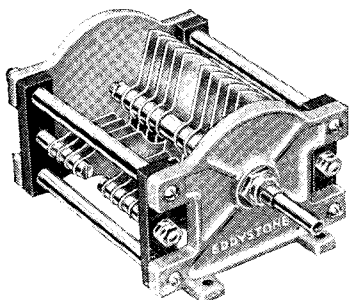

The Catalogue Nos. 1081 and 1082 Condensers are for low voltage transmitting work and have a peak flashover voltage of 3,500 volts. Insulation is provided by D.L.-9 High Frequency mouldings, the materials being out of the direct electrostatic field of the vanes and of minimum size to ensure low dielectric losses.

Plate spacing is 0.087 in. stator to rotor surfaces. The stator plates have adequate clearance when condenser is mounted horizontally on a metal base, rigid fixing being ensured by cast end plates.

Terminal connections are fitted with 2 BA nuts. Spindle diameter $\frac{1}{4}$ ".

CAT. No. 1082. .0001 mfd. single capacity. Code TRUM. PRICE, **16 6**

CAT. No. 1101. .0002 mfd. single capacity. Code TRIP (3000v. Peak). PRICE, **22 6**

CAT. No. 1102. .0003 mfd. single capacity. Code TROK (3000v. Peak). PRICE, **27 6**

CAT. No. 1081. 50 m.mfd. \times 50 m.mfd. Split Stator. Code TRUP. PRICE, **17 6**

Special capacities to order.

7,000 PEAK VOLTAGE TYPE

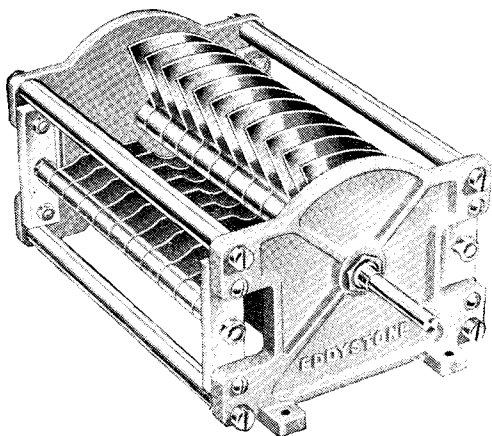

The Catalogue Nos. 1078 and 1080 models are for high power equipment and have a peak flashover voltage of 7,000 volts. They have ceramic (Frequentite) insulation. As in the low voltage types they are constructed to ensure low dielectric losses and provide adequate clearance for the stator plates when the condenser is mounted horizontally on a metal base. Plate spacing is 0.187 in. stator to rotor surfaces. Terminal connections have 2 BA nuts. Both high and low voltage types have highly polished rounded edge aluminium vanes of 0.034 in. thickness.

Spindle diameter $\frac{1}{4}$ ".

NOTE. The midget stand-off insulator (CAT. No. 1019) provides a suitable mount for this range of condensers. (See Page 13).

CAT. No. 1078. .0001 mfd. single capacity. Code TRANK. PRICE, **35 -**

CAT. No. 1080. 40 m.mfd. \times 40 m.mfd. Split Stator. Code TRINK. PRICE, **36 -**

Special capacities to order.



Transmitting Condensers

3,500 PEAK VOLTAGE ALL BRASS TYPE.

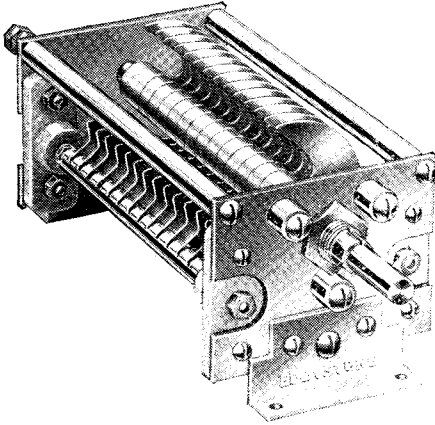

A useful Transmitting Condenser with small physical dimensions. All Brass construction, soldered vanes and Frequentite insulation. Dual mounting for either baseboard or panel. Rigid construction and substantial bearings. $\frac{1}{4}$ " spindle. Peak flashover voltage 3,500 volts. Minimum capacity, 14 m.mfd. Maximum, 65 m.mfd.

CAT. No. 1083. Code TRUX.
PRICE .. **16/6**

Dimensions in Inches.

Cat. No.	A	B	C	D	E	F	G	H
1078	$2\frac{11}{16}$	6.66	$4\frac{3}{8}$	6.20	$1\frac{1}{2}$	3.42	1.86	$\frac{1}{4}$
1080	$2\frac{11}{16}$	6.66	$4\frac{3}{8}$	6.20	$1\frac{1}{2}$	3.42	1.86	$\frac{1}{4}$
1081	2.08	$4\frac{3}{8}$	$3\frac{5}{8}$	4	$1\frac{1}{2}$	$2\frac{3}{4}$	$1\frac{1}{2}$	$\frac{1}{4}$
1082	2.08	$3\frac{7}{8}$	$3\frac{5}{8}$	$3\frac{3}{4}$	$1\frac{1}{2}$	$2\frac{3}{4}$	$1\frac{1}{2}$	$\frac{1}{4}$
1083	$1\frac{1}{4}$	$4\frac{5}{8}$	$2\frac{3}{16}$	$4\frac{3}{32}$	$1\frac{5}{16}$	$1\frac{15}{16}$	$1\frac{1}{16}$	$\frac{1}{4}$

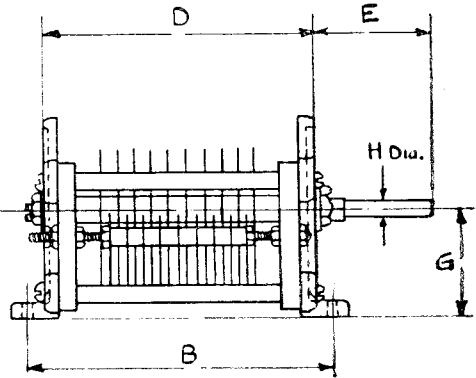
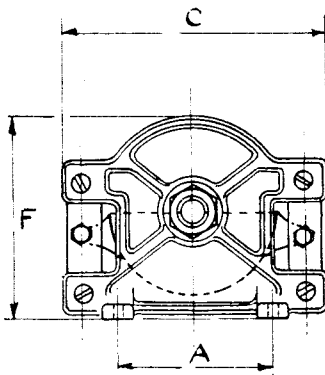

EDDYSTONE

New Type Microdensers

In the new type microdensers we have changed from Frequentite Ceramic insulation to D.L.-9 insulation owing to the better properties of this latter material for small condenser use. The minimum capacities of all sizes are much reduced and the smaller sizes have considerably wider vane spacing so they can be used with high voltages. Irrespective of capacity, all condensers are of the same overall dimensions, with $\frac{1}{4}$ " spindle extended for ganging. The construction is of brass with all vanes soldered to give low series resistance at high frequencies and lacquered to prevent oxidation. The capacity and efficiency are constantly maintained despite age. The unequalled efficiency of the "EDDYSTONE" microdenser can be judged by the fact that it is practically impossible to measure any change in "Q" of an efficient coil when the microdenser is connected across it.

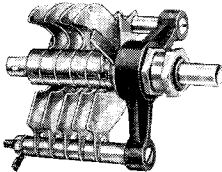

CAT. No. 1094.

CAT. No. 1094. 18 m.mfd. high voltage type.
Minimum capacity, 3 m.mfd. Maximum, 18 m.mfd.
D.C. flash-over voltage, 3,500 volts.
Code POWRX. PRICE .. **3 9**

CAT. No. 1129. 40 m.mfd. high voltage type.
Minimum capacity, 3.8 m.mfd. Maximum, 40 m.mfd.
D.C. flashover voltage, 2,300 volts.
Code PRIMP. PRICE .. **4 3**

CAT. No. 1093. 60 m.mfd. high voltage type.
Minimum capacity 4 m.mfd. Maximum, 59.5 m.mfd.
D.C. flashover voltage, 2,300 volts.
Code POWJK. PRICE .. **4 6**

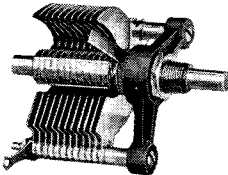

CAT. No. 1131.

CAT. No. 1130. 100 m.mfd.
Minimum capacity, 4.5 m.mfd. Maximum, 100.5 m.mfd.
D.C. flash-over voltage, 1,000 volts.
Code PRILP. PRICE .. **5 -**

CAT. No. 1131. 160 m.mfd.
Minimum capacity, 4.75 m.mfd. Maximum, 161 m.mfd.
D.C. flash-over voltage, 1,000 volts.
Code PRINK. PRICE .. **6 -**

Air Dielectric Trimmer

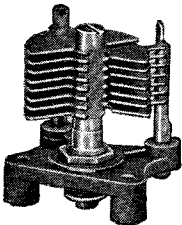

This condenser is mounted on a base of D.L.-9 low loss dielectric. It can be used for all pre-set and trimming purposes but has been particularly designed for use with intermediate frequency transformers. It is mounted by means of two small moulded pillars on the base and the spindle is slotted at each end so that adjustment can be made from the top or bottom. The tension is such that it will not alter when set. The minimum capacity is 3 m.mfd. and the maximum capacity 65 m.mfd.

CAT. No. 978. Code DITRI. PRICE **3 6**

Midget Condensers

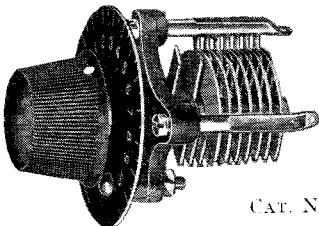

A condenser of small size suitable for trimming, balancing or band-spreading. The design is similar to the air dielectric trimmer No. 978 with slotted spindle extended and fitted with engraved scale and knob.

CAT. No. 1013. Min. Cap., 3 m.mfd. Max. Cap., 65 m.mfd.
Code TRID. PRICE .. **4 3**

CAT. No. 1132. Min. Cap., 2 m.mfd. Max. Cap., 12 m.mfd.
Code TRIB. PRICE .. **4 -**



EDDYSTONE

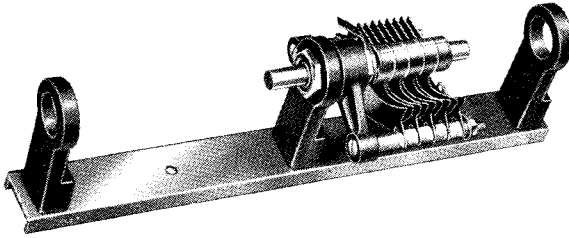

Condenser Cradle

This novel condenser cradle enables three standard microcondensers to be mounted into the form of a three gang condenser unit.

Insulated flexible couplers are used between the condensers so that a gang condenser is obtained with both rotors and stators completely isolated. Furthermore, any value of gang can be made up. Split stator condensers of any microdenser value using two condensers are a further variation and many special alternatives will readily come to mind. The condenser units are always usable again as separate condensers. The cradle comprises a sectional brass base with D.L.-9 insulated brackets. Brass division plates already drilled are available for screening the condenser units.

CAT. No. 1114.

Cradle.

Code CRADL.

PRICE **3 6**

CAT. No. 1125.

Metal Screens.

Code SRACL.

PRICE **8d.** pair.

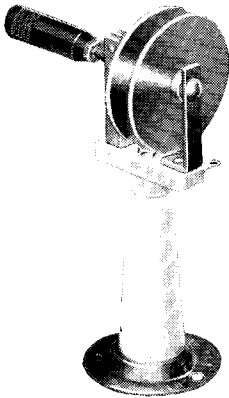

Neutralising Condenser

Of small physical dimensions and eminently suitable for neutralising in ultra high frequency circuits using low capacity triode valves. Maximum voltage at maximum capacity, 2,000 volts D.C. Will withstand higher voltages when adjusted to lower capacity. Capacity variation 1-8 m.mfd. Glazed Frequentite pillar insulator for mounting; insulated adjusting knob.

CAT. No. 1088. Code NEUBX. PRICE .. **6 6**

CAT. No. 1067. 2-12 mmfd. PRICE .. **12 6**

Slow Motion Reaction Condenser

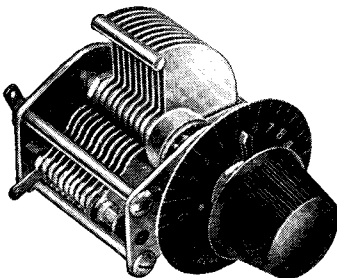

A fine degree of accuracy for reaction control in a short wave receiver is obtained with this condenser. It has a 10:1 vernier motion which is perfectly smooth and responds to the slightest touch without back-lash. The condenser is made with all brass vanes in capacity .0002 mfd. which has been found suitable for general requirements. It is supplied with knob, pointer and dial.

CAT. No. 957. .0002 mfd. Code ERICA. PRICE **6/-**



Bandspread Tuning Outfit

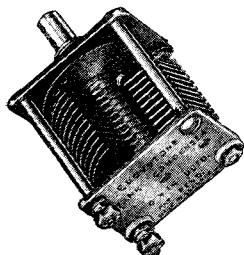

PAT. PENDING.

Tank Unit. No. 1042. PRICE **6** -
Code TANKT.



The "EDDYSTONE" bandspread method of short wave tuning is devised to simplify station selection. Two Condensers are used, the first or Tank Condenser being a compact Air Dielectric unit having a capacity range of 10 - 14 m.mfd. This is achieved with a patented stop device graduated in 10 steps. Each step covers a capacity of 14 m.mfd., band settings being accurately pre-determined and controlled by a black bakelite switch knob moving over a metal dial plate graduated 0-10.

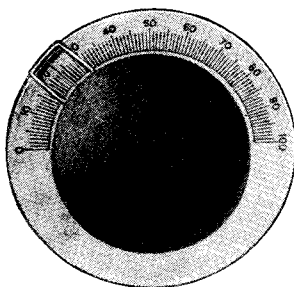

Bandspread Unit. No. 1043. PRICE **6 6**
Code TRIMT.

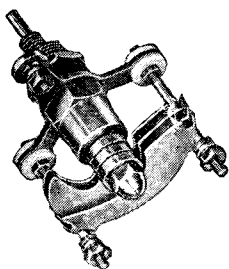

Parallel with the Tank capacity, the "EDDYSTONE" bandspread slow motion trimmer having 9-1 reduction ratio is used. It has a capacity range slightly greater than each separate step of the Tank Condenser. This enables each 10th section of the whole to be spread over 180°, and provides a tuning ratio of 90-1. It gives a definite advantage in short wave tuning, in that a fairly large movement of the bandspread condenser is necessary to effect small changes in tuning, thus separating stations which with generally accepted tuning circuits appear too close to one another to allow clear

separation. The trimmer is absolutely noiseless in operation and has a smooth positive control action.

Beat Frequency Oscillator Unit

450-470 Kc. s.

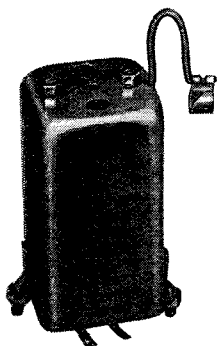

Mounted in a small aluminium can $2\frac{3}{4}$ " high \times $1\frac{3}{8}$ " square, arranged to give an electron coupled oscillator circuit in conjunction with a 6J7 valve. The unit incorporates a double trimmer having a large and small capacity for coarse and fine tuning. A grid leak and condenser is also included. Grid lead is brought out of top of can and fitted with clip. A midget condenser, Cat. No. 1132, can be used in conjunction with this unit should it be desired to vary pitch of beat note from front panel.

CAT. NO. 1119. Code BETFO. PRICE .. **8 6**



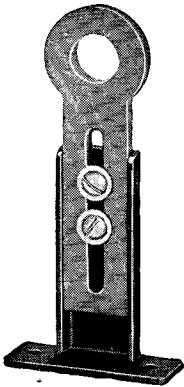

Adjustable Insulated Bracket

D.L.-9 INSULATION. (PATENT PENDING).

A sturdy and strong bracket for mounting components which are controlled from an extension spindle or flexible coupler. The insulated portion, which is made from D.L.-9 high frequency dielectric, is adjustable, giving the mounting hole centres of $2\frac{1}{2}$ " to $3\frac{1}{2}$ " from the baseboard. The size of hole is $\frac{13}{32}$ " or $\frac{7}{16}$ " clearance. The metal one-piece slide is finished brown and clamps to baseboard with two screws.

CAT. No. 1007.

Code ADJO.

PRICE 1 6

Extension Control Outfit

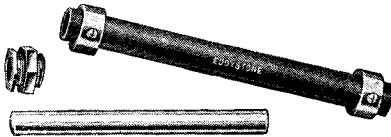

The insulating portion of this outfit is made from precision drawn paxolin tube of high quality which cannot warp or bend, as does ebonite. The length of the insulating part is 4", while the $\frac{1}{4}$ " brass insert is 3" long, giving ample scope for length adjustment. A panel bush and nut are supplied in brass $\frac{3}{8}$ " outside dia.

CAT. No. 1008.

Code STEN.

PRICE 1 3

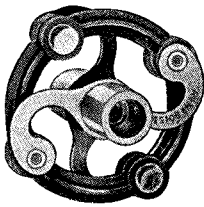

REG. DESIGN

Flexible Coupler

The design of this coupler is such that although completely flexible, it is free from back-lash. The insulating portion is of D.L.-9 low loss dielectric and the spring metal arms are phosphor bronze. It facilitates the lining up of coupled components ensuring a smooth, free drive. The diameter of the coupling is $1\frac{1}{8}$ " and the metal bushes take a $\frac{1}{4}$ " spindle, and are each fitted with two grub screws.

CAT. No. 1009.

Code OPLEX.

PRICE 1 6

Flexible Driving Shaft

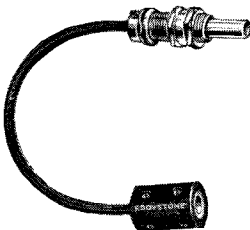

Cable length $5\frac{1}{2}$ ".

A flexible cable coupling shaft which is highly recommended for front panel control of components which are awkwardly located above or below chassis. Will drive through 90° perfectly. A Keramot insulating hub fitted with brass bush and two grub screws takes $\frac{1}{4}$ " spindle. The driving end has $\frac{1}{4}$ " shaft, and is provided with brass bush for securing to panel by $\frac{3}{8}$ " fixing hole. Is recommended for all purposes except tuning drives where extreme freedom from backlash is essential. (Due to the length of cable a slight degree of "whip" is evident).

CAT. No. 1096. Code FLEXR.

PRICE .. 3 6



EDDYSTONE

Improved Dual Speed Dial

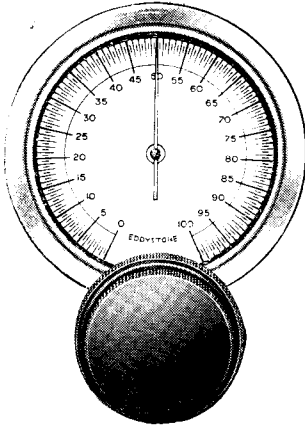

The new "EDDYSTONE" full vision dual speed dial has many features which appeal to the critical constructor. The movement is superbly silky in action without backlash on both the 20-1 and the 100-1 speeds. For high frequency work the movement is specially designed to eliminate noise. The open vision scale is clearly readable and divided into 100 graduations. Half division marking ensures accurate settings of the indicator pointer. The readings are arranged to increase as the frequency increases, which is in keeping with modern practice. The movement can be mounted from panel or baseboard. The dial face fits on the front of the panel so that no large panel gap has to be cut unless it is desired to illuminate the scale from the back. The dial can be used on panels up to $\frac{1}{4}$ " thick and takes the standard $\frac{1}{8}$ " spindle, and is beautifully finished in oxidised silver relief.

CAT. No. 1070. Code DUALX. PRICE . . 106

Precision Slow Motion Dial

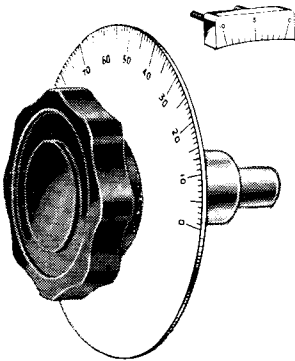

An instrument type driving movement with slow motion ratio of 6-1 and vernier indicator which allows accurate readings to 1/10th of a division. It is eminently suitable for high-class test and laboratory equipment, transmitters and receivers. The white metal scale is 4" diameter, 5/64th" thick, and has machine cut markings with black filling. A 2 1/2" fluted control knob gives positive finger grip; the drive is made to take 1/8" spindles.

CAT. No. 1085. Code DUNTE. PRICE 15 -

A popular type of the above dial with attractive aluminium satin finish printed scale and single line indicator block is also available.

CAT. No. 1115. Code POPDE. PRICE 10 -

Precision Direct Drive Dial

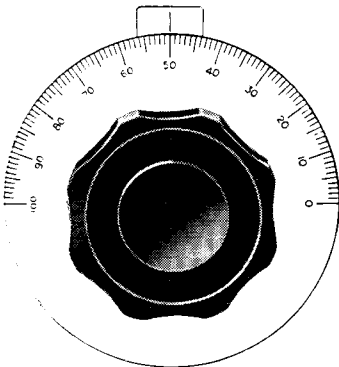

An instrument finish dial with 2 1/2" fluted control knob. The white metal scale, 4" diameter and 5/64th" thick, is machine engraved with engravings filled black. Single line indicator block. Suitable for laboratory and test equipment.

CAT. No. 1077. Code DUNPA. PRICE 69

A popular type of the above drive with a printed scale in satin finish aluminium is available.

CAT. No. 1098. Code DOWKO. PRICE 46

CAT. No. 1077.



Miniature Precision Finish Dial

DIRECT DRIVE

This is a smaller edition of the Cat. No. 1077 dial, and with the same high grade finish. The $2\frac{3}{8}$ " white metal scale has machine cut markings with black filling. It is fitted with a $1\frac{1}{8}$ " fluted control knob and a single line indicator.

CAT. No. 1097. Code DINJP. PRICE .. 4-

MINIATURE POPULAR FINISH DIRECT DRIVE DIAL
A popular type of dial which will appeal to the Amateur experimenter. The $2\frac{3}{8}$ " scale is satin finished aluminium with clearly marked divisions. It is fitted with a $1\frac{1}{8}$ " control knob for $\frac{1}{4}$ " spindles. A single line indicator is provided.

CAT. No. 1099. Code DIFMR. PRICE .. 2-

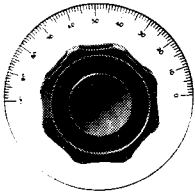

Small Pointer Knob and Dial

A $1\frac{1}{4}$ " aluminium dial plate finished black and marked 0-10 in white letters. $\frac{1}{4}$ " or $\frac{3}{8}$ " hole as desired. Black bakelite pointer knob for $\frac{1}{4}$ " spindle, fluted grip and tapering pointer with engraved white line.

CAT. No. 1044. Code INDIP. PRICE .. 1-



Insulated Bracket

A small insulated fixed bracket is an item that is handy for innumerable purposes. D.L.-9 insulation of ample strength is mounted on a brass fixing base. The construction is such that the insulation cannot turn on the base. Fixing centre height is $1\frac{1}{2}$ ".

CAT. No. 1116. Code BRAKT. PRICE 13

Pointer Knob and Dial

A straight through control with $3\frac{1}{2}$ " satin finish aluminium dial, engraved 0-100° in black. The pointer knob is of elegant shape in black bakelite, has fluted grip and tapering pointer with engraved white line. For $\frac{1}{4}$ " spindles only.

CAT. No. 1027. Code OSKO. PRICE 13

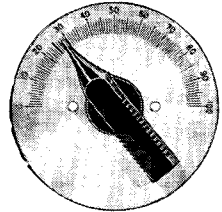

Instrument Knobs

CAT. No. 1076. A $2\frac{1}{2}$ " diameter high-grade fluted instrument knob in polished black bakelite with brass insert for $\frac{1}{4}$ " spindle. The design ensures positive finger grip and steady control. Two set screws 90° apart assure the knob a secure fitting on the instrument spindle.

Code KNOBO. PRICE .. 2/-

CAT. No. 1089 is a $1\frac{1}{8}$ " diameter instrument knob in black bakelite, embodying the same construction as Cat. No. 1076; fitted with two set screws and brass insert for $\frac{1}{4}$ " spindle. To facilitate fitting of dial or pointer, a dowel is moulded on underside of knob and brass insert projects slightly to allow for rivetting.

Code KNOKR. PRICE .. 13

CAT. No. 1086. A popular type $1\frac{1}{8}$ " diameter control knob for $\frac{1}{4}$ " spindles. Fitted with one grub screw but without brass insert.

Code KNOJM. PRICE .. 9d.

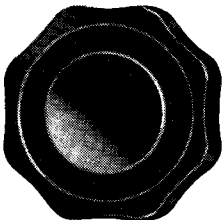

CAT. No. 1076.



CAT. Nos. 1086, 9



EDDYSTONE

Featherweight Crossfeeder Block

FOR ELIMINATION OF MAN-MADE INTERFERENCE
ON SHORT WAVE AERIAL SYSTEMS.

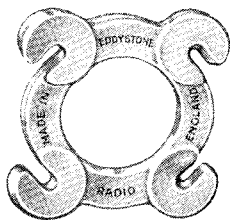

This Crossfeeder Block is of minimum size to give $1\frac{1}{8}$ " line spacing. This distance has been found the most effective.

In many cases reception of weak short wave signals is difficult, owing to man-made interference from electrical apparatus in the near vicinity. By the use of a doublet type aerial, erected as high as possible and out of the general field of interference and the employment of the special "EDDYSTONE" crossfeeder system of lead-in, this man-made static can be very largely eliminated. Full details will be supplied on request.

The Featherweight Crossfeeder Block is made of transparent thermo plastic material, impervious to moisture, practically unbreakable, and possessing remarkable high frequency insulating properties. These blocks have many other uses, including transmission lines for use with transmitting aerials.

CAT. No. 1041. Code CROFX. PRICE **4 6** per doz.
(boxed in lots of 6).

Low Loss Frequentite Valveholders

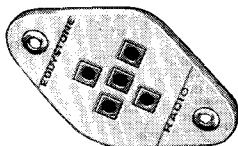

These Valveholders are of genuine low loss construction, the Frequentite insulating material being the finest that can be obtained for high frequency use.

The Clix patent one-piece semi-floating sockets ensure absolute alignment and maximum resilient contact with valve pins.

The special metal inserts protect the Frequentite base from breakage when mounting on chassis.

The sockets have specially shaped ends to facilitate soldering.

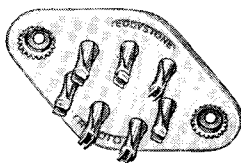

CAT. No. 1073. 4-pin. Code KLIP. PRICE **9d.** each
CAT. No. 1074. 5-pin. Code KLIM. PRICE **10d.** each
CAT. No. 1075. 7-pin. Code KLIN. PRICE **1 -** each
CAT. No. 1120. Octal. Code KLOX. PRICE **1 3** each

S.W. Baseboard Mounting Valveholder

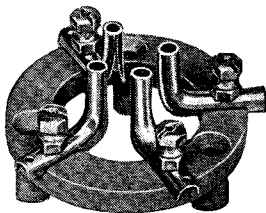

This valveholder is of low loss construction, the insulating ring being made from Frequentite. The holder is raised by small pillars from the baseboard and the metal sockets are of one piece construction so that all chance of noise through separate pieces being joined together is obviated.

CAT. No. 949. 4-pin. Code EVIX. PRICE **1 5**
CAT. No. 950. 5-pin. Code EVOX. PRICE **1 8**



Ultra Short Wave H.F. Choke



This Choke has the "EDDYSTONE" patented end connection, providing a sound anchorage for the winding, which is not disturbed when using the wire ends for mounting. There is no undesirable metal end cap or shorted loop in the field of the choke. It is single layer space wound on a D.L.-9 former and has an exceedingly low self-capacity. Due to its small size and light weight, it mounts conveniently.

CAT. No. 1011. D.C. resistance 1.3 ohms. Inductance 5.6 microhenries.
Code FREK. 2.5-12 metres. PRICE **1 3**

Short Wave H.F. Chokes



The "EDDYSTONE" patented low loss end connection as described above is also used on these chokes. D.L.-9 formers are used with four honeycomb-wound coils spaced apart. Due to their small size and light weight, they mount easily in the wiring. They have a very low self-capacity and are quite free from resonant peaks over the wave range covered.

CAT. No. 1010. D.C. resistance 22 ohms. Inductance 1.25 millihenries.
Code OFRA. 5-180 metres. PRICE **2 -**

CAT. No. 1022. D.C. resistance 10 ohms. Inductance 1.5 millihenries.
Heavy duty for transmitters to carry 250 m. amps.
Code OFTA. 5-180 metres. PRICE **3 -**

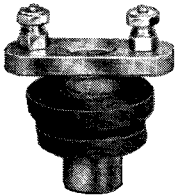

All Wave H.F. Choke

An All Wave Choke of compact size with terminal connections. Low loss D.L.-9 former with two section honeycomb wound coils. One screw fixing to baseboard or chassis. Wavering 12.5 to 2,000 metres. Self capacity 2.4 m.m.f.d. Inductance 17.9 millihenries. D.C. resistance 60 ohms.

CAT. No. 1066. Code TERMK. PRICE **2 -**

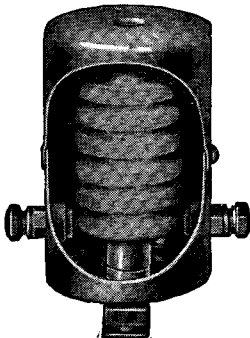

Screened All Wave Choke

The All Wave Choke No. 982 is for universal use on wavelengths between 13 and 2,000 metres. It comprises six honeycomb coils spaced apart on a hollow Steatite tube and mounted in a copper screening container. The natural wavelength is over 2,400 metres and it gives great satisfaction with freedom from resonant peaks on the short wavelengths and broadcast bands.

CAT. No. 982. All Wave Choke, 13-2,000 metres.
Code UFRE. PRICE **3 6**



EDDYSTONE

Glazed Frequentite Former and Base

A Frequentite ceramic former for transmitting and other high frequency apparatus. The former is 5" x 2½" and may be mounted as illustrated or on Frequentite pillar insulators. Cat. Nos. 1049, 1095 (page 14). Spiral grooves take 26 turns of wire up to 12 gauge; 14 holes are provided for leads and tapping connections. Each former is supplied with winding data for Amateur frequencies, and is designed for coils up to 90 metres.

CAT. No. 1099.

Code FORMX.

PRICE .. 4.-

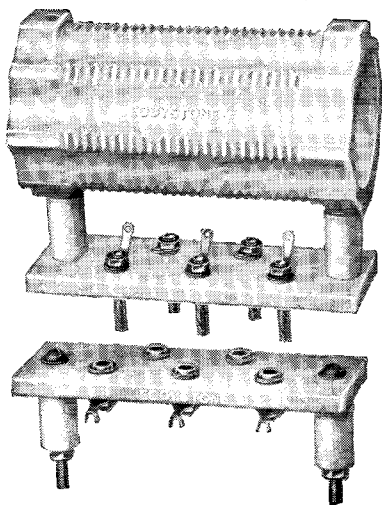

FREQUENTITE SUB-BASE

The sub-base is also in Frequentite ceramic and is easily attached to the former by two bolts and Frequentite pillars. It can be used separately as a base for self supporting Inductances. Helicly slotted power plugs give positive electrical contact and even fitting to ceramic is assured by lead washers. Leads are secured by heavy gauge tinned phosphor bronze self-locking soldering tags.

CAT. No. 1091.

Code FOSUB.

PRICE 3.6

FREQUENTITE BASE

The base is provided with Frequentite pillars for above chassis mounting. Heavy duty power type sockets give sound electrical connection with sub-base and lead washers on each socket ensure even fitting to ceramic. Leads are secured by heavy gauge tinned phosphor bronze self-locking soldering tags.

CAT. No. 1092.

Code FOBAS.

PRICE 3.9

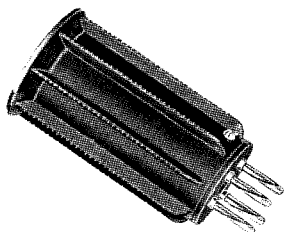

S.W. Coil Formers

These coil formers have 8 ribs with an outside diameter 1½", winding space is 2¼". The threaded formers carry 14 threads to the inch. They are identical formers as used for "EDDYSTONE" coils. The bases on these formers are detachable for easy wiring. D.L.-9 DIELECTRIC.

CAT. No. 935.

4-pin, plain.

PRICE 2.-

CAT. No. 936.

4-pin, threaded

PRICE 2.3

CAT. No. 1002.

6-pin, plain.

PRICE 2.3

CAT. No. 1003.

6-pin, threaded

PRICE 2.6

CAT. No. 1001.

5-pin

PRICE 2.6

Low Loss Aerial Lead-in

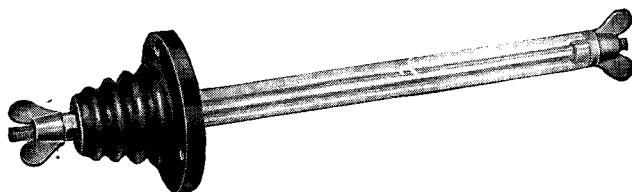

The outside insulator is of special vitreous porcelain which will withstand the weather and has a long leakage path between the metal connecting portion and earth. The

tube itself is of ½" diameter, high tensile strength glass with special electrical qualities. The metal portion is polished and nickel plated and wing nuts are fitted at both ends for general convenience. A special moulded rubber washer fitted inside the cone prevents breakage, allows for errors in mounting, and is watertight.

CAT. No. 946. Code EADIN. Length of glass tube behind insulator 5¾". PRICE 2.6

CAT. No. 972. Code EODIN. Length of glass tube behind insulator 11". PRICE 3.6



Aerial Strain Insulator

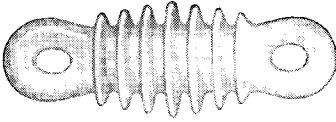

Overall Length, 3½".

CAT. No. 999. Code INSA PRICE **9d.**

A highly efficient insulator for use in high frequency transmitting or receiving aerial design. Has exceptionally long leakage path, is highly glazed against damp and with a breaking strain of 400 lbs. Made from Steatite, which is superior to glass or porcelain in respect of mechanical strength and low loss properties.

Bar Insulator



Spacing Distance, 2".

CAT. No. 1017. Code ATOR. PRICE **46** doz.

FREQUENTITE.

An exceptionally useful insulator for strain or spacer purposes. It is made in Frequentite, so that it is ideal for ultra short wave work. As a feeder spacer, it is intended that the wires run parallel with the ends, which are slotted for this purpose. The wires can be secured in place with insulated wire or twine through the main holes.

Lead-through Insulator

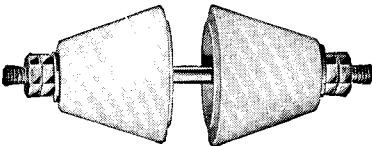

Cones 1½" long. 1¾" max. diam.

CAT. No. 1018. Code LADOR. PRICE **2.-**

FREQUENTITE.

This insulator is primarily designed for carrying high frequency leads through metal baseboards with a minimum of loss. The insulator cones are of glazed Frequentite and are flanged at the bottom, to centre into the baseboard. A 4BA brass rod is used as the conductor. They are ideal in transmitters constructed on the rack principle. Lead washers are supplied to prevent breakage of the cones.

Midget Stand-off Insulator

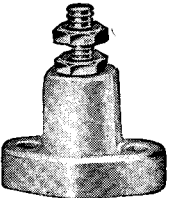

Actual Size.

FREQUENTITE

A small midget mounting insulator made from Frequentite with N.P. brass parts. A most useful accessory in the design of ultra short wave receivers and transmitters. The new quality Frequentite used closely approaches quartz in its characteristics as a low loss dielectric at high frequencies.

CAT. No. 1019. Code MIDE. PRICE **46** doz.



Frequentite Terminal Saddle

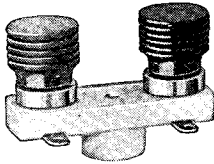

These 2-way saddles are particularly suited for H.F. work, being mounted on a low loss Frequentite base, with one hole fixing, and provided with sturdy 4BA terminals with insulated heads coloured red and black. Soldering tags are also fitted. They can be used for a multiplicity of experimental purposes.

CAT. No. 1046. Code MINIX. PRICE 1 -

Insulating Pillars

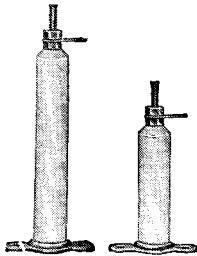

Most useful for mounting components in ultra short wave receivers. Made in two heights with white D.L.-10 insulating portion $2\frac{1}{2}$ " or $1\frac{1}{2}$ " long by $\frac{7}{16}$ " diameter. N.P. metal foot with 2-hole fixing and long 6BA screw shank (adjustable) at top.

CAT. No. 1028. $2\frac{1}{2}$ " Pillar. Code PILOX. PRICE 6 - doz.

CAT. No. 1029. $1\frac{1}{2}$ " Pillar. Code PILAX. PRICE 4 6 ..

Stand-off Insulator



The "EDDYSTONE" Stand-off Insulator will find many uses in the experimenter's and transmitter's laboratory. It is ideal for mounting inductances, meters, spacing inside aerial feeders, and, in fact, for all insulating purposes where high voltages have to be carried. It is made from special quality vitreous porcelain, glossy brown finish, with hollow centre and is supplied complete with terminal wing nut, all metal parts being heavily nickel plated.

PRICE .. 1 -

CAT. No. 916. Code ACBX

Frequentite Pillar Insulators

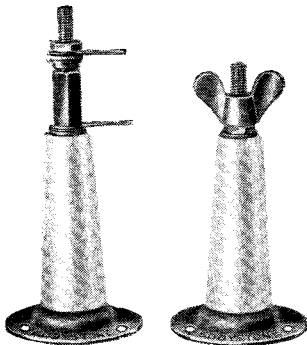

No. 1095.

No. 1049.

The "EDDYSTONE" Pillar Insulator is made of glazed Frequentite and tested to a breakdown voltage of 30,000. It is recommended for transmitting and laboratory work, being ideal for mounting inductances, meters, bus-bars, spacing aerial feeders, and for all high voltage insulation.

Supplied in two types, one having a 2 BA fixing bolt and wing nut, the other a heavy duty plug and socket fitting with soldering tag connections.

The glazed finish makes the insulator impervious to weather conditions and it is highly suitable for outdoor insulation.

A three hole fixing metal base affords easy mounting and a shakeproof non-slip washer prevents the insulator cone twisting in use.

CAT. No. 1049. Code ACBP. PRICE 1 6

CAT. No. 1095. Code ACSX. PRICE 1 8

Spare heavy duty plugs for Cat. No. 1095 .. 2½d. each.



EDDYSTONE



Hand Microtelephone

P.O. pattern in moulded black bakelite case. Immersed electrode Microphone gives strong and good quality speech. Highly sensitive 1000 ohm earpiece. Very suitable for Ultra Short-wave radio telephones.

CAT. No. 1071. Code MICRA. PRICE **27 6**

Matched Microphone Transformer. CAT. No. 1079. Code MEKA. PRICE **16 -**

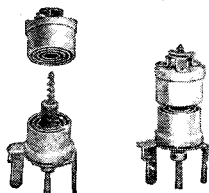

Short Wave Air Trimmer

A compact short wave air dielectric trimmer possessing unique features in construction; capacity variation is 1 m.mfd. to 30 m.mfd. with special spiral rotor adjustment which ensures finely graded control and constant setting. The trimmer has an unusually low minimum capacity. Soldering tag connections.

CAT. No. 1100. Code PLODX. PRICE .. **1 3**

Short Wave Mica Trimmer

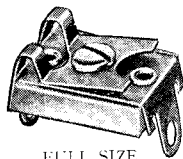

FULL SIZE

A small trimming condenser which is invaluable in short wave or all wave sets for balancing, trimming or padding purposes. The adjustment is positive and gives variation of capacity from 4 m.mfd. to 30 m.mfd. Mica insulation is used on a light weight base made from the new quality Frequentite.

CAT. No. 1022. Code PADA. PRICE **1 -**

Quench Coil Unit

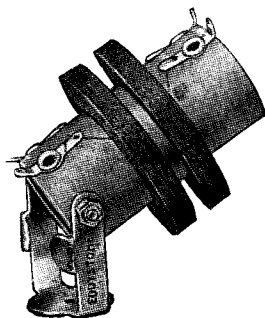

The use of a super-regenerative type of set for 5-metre reception is exceedingly popular, due to advantages which this type of circuit has for such work. The quench unit for this purpose comprises two honeycomb self-supporting coils wound $\frac{1}{4}$ " apart on a paxolin former, the whole being mounted on a metal stand which permits of vertical or horizontal mounting. Used as the grid coil, it should be tuned with a .006 mfd. condenser when the quenching frequency is approximately 20 kc/s. This frequency is found to be best in practice.

CAT. No. 958. Code ENCHA. PRICE **4 6**

Telescopic Aerial

FOR THE 56 M.cs. BAND.



The aerial length is such that it can be adjusted to resonate at any frequency in the 5 metre band and allows for the additional length required for reflector purposes. It is made from Duraluminium tubes, the two top sections telescoping. The total height extended is 9' 3", and when fully telescoped 3' 3". A heavy base easily supports the aerial when extended. A terminal connection with the tubes and a free terminal for feeder lines is provided in the bottom insulating sleeve.

CAT. No. 1038. Code TELAS. PRICE .. **12 6**



EDDYSTONE

4 and 6-Pin Lead Connectors

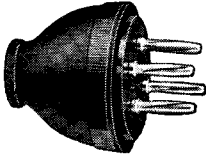

The spring pins are moulded into a bakelite disc which is sprung into a rubber housing. Makes an ideal connector for leads used with valveholders No. 953 or 964. For obvious reasons, the rubber housing has advantages over the solid bakelite type.

CAT. No. 1030. 4-pin. Code ROPLU. PRICE **1 2**
 CAT. No. 1031. 6-pin. Code ROPLF. PRICE **1 3**

Slow Motion Driving Head

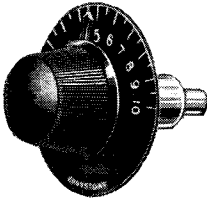

Supplied with 0-10° 1½" engraved scale.

and compact slow motion tuning drive. It is recommended that the flexible coupler, Cat. No. 1009 as shown on page 7, be used in conjunction with it.

CAT. No. 1012. Code DRIAD. PRICE **3 -**

This slow motion driving head has a 9:1 reduction ratio with the pointer moving through 180°. It is very useful for slow motion control of components mounted from an extension spindle and in the design of ultra short wave receivers, enables the component in question to be mounted in the best position for short wiring. Also in transceiver design, it affords a very small

Valve Shield

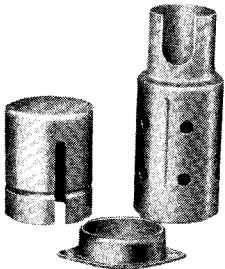

The outfit consists of three aluminium parts comprising the valve base, the body and the top. The base is made so that it has standard hole fixing with the standard chassis mounting 4, 5 pin and Octal Valveholders.

CAT. No. 1121. Code SHILD. PRICE .. **1 3**

Air Tuned I.F. Transformer

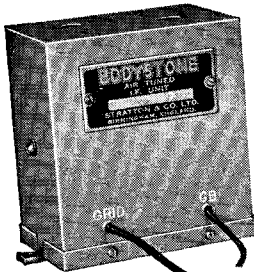

Size 2½" × 2" × 3½".

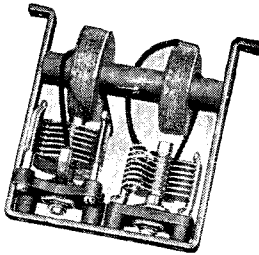

soldered metal container. Trimming adjustment is from the top and the adjustment of the condensers is such that they will not move when once set. The total tuning range of the unit is from 400-500 kc/s, allowing ample safety margin for circuit loading. The transformers are highly efficient and give a bandwidth of approx. 7 kc/s.

CAT. No. 1014. Code TRAF. 450 kc/s. PRICE **8 9**

LITZ WOUND.

Considerable thought has been given to the design of these transformers to make them as efficient as possible in a reasonably sized container. Two "EDDYSTONE" No. 978 Air Trimmer Condensers are used, while the primary and secondary windings of the transformer are wound with genuine 9.45 litz wire, the whole unit being shielded in a



EDDYSTONE

STEEL TRANSMITTING RACKS

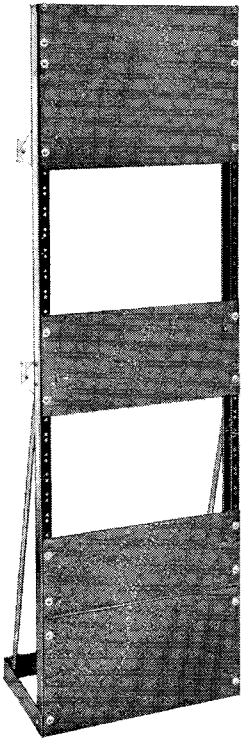

Showing front view of complete relay rack and extension outfit, 63" panel space (36" x 1 3/4" units). Any combination of panel sizes can be used. Smart appearance, attractively finished, and will easily carry all weight required. (A 13-stone man can stand on top tray).

COMPLETE RELAY RACK (A).

International standard sizes throughout, comprising welded steel base, vertical steel channels fully drilled and tapped to take any panel combination with steel tie bars and all nuts and bolts, finished black throughout, 31 1/2" panel space (18" x 1 3/4" units), can be extended at any later date to full size 63" panel space.

RELAY RACK EXTENSION OUTFIT (B & C).

31 1/2" panel space (18" x 1 3/4" units), comprising vertical steel channels as above, steel jointing channels and brass oxidised nuts and bolts.

CAT. No. 1107. PRICE **25/-**.

STEEL CHASSIS (D).

Welded corners, 16 g. .0625 thick, size 17" x 10" x 2", finished black. Drilled for bracket fitting.

CAT. No. 1109. PRICE **4/6**.

STEEL BRACKETS (E).

Inturned edge to carry chassis 16 g. .0625" thick, drilled for panel and chassis fitting, finished black.

CAT. No. 1110.

PRICE .. **2/6** per pair.

Black oxidised brass bolts and nuts (4 are required for fastening chassis to bracket and 4 panel to bracket).

CAT. No. 1111.

PRICE .. **1/3** per dozen.

STEEL PANELS (F).

1/16" thick, slotted for rack mounting, and drilled for brackets, black ripple finish, does not hold dust.

No. 2.	19" x 3 1/2"	2/3
No. 4.	19" x 7"	3/-
No. 5.	19" x 8 3/4"	3/9
No. 6.	19" x 10 1/2"	4/-

CAT. No. 1112.

Round head black oxidised brass bolts and washers for mounting panels to rack (4 needed).
CAT. No. 1113. PRICE .. **1/3** dozen.

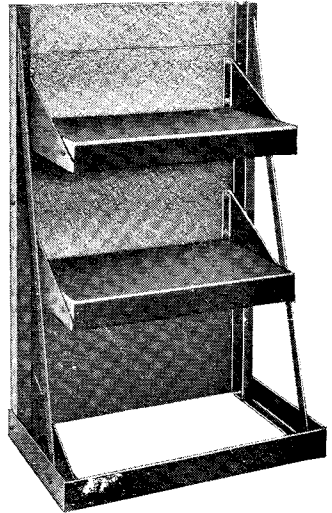

Back view of a complete rack assembly, 31 1/2" panel space. At any later date this can be extended to full size with extension outfit (B, & C).

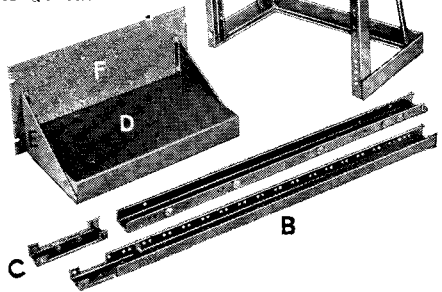
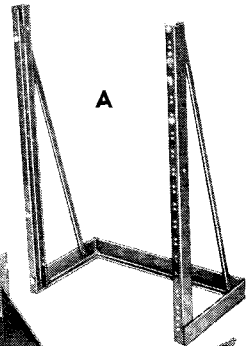

A small view showing the individual parts for relay rack assembly. These can be purchased to suit requirements.



EDDYSTONE

Die-cast Aluminium Chassis

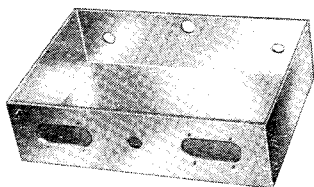

This chassis provides a strong and rigid foundation for all kinds of small receivers, H.F. amplifiers, power supply packs, etc. It measures $8\frac{1}{2}'' \times 5\frac{3}{4}''$ top baseboard sizes, and is $2\frac{3}{8}''$ deep. Two bakelite terminal panels are provided for the existing cast in apertures.

CAT. No. 1117. Code CHASO.

PRICE .. 5/6

Plain Undrilled Metal Panel.

No. 1118, 1/9 Extra.

Metal Cabinets

DIE-CAST.

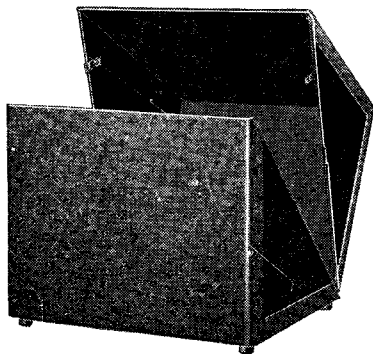

Size, $9\frac{1}{2}'' \times 8'' \times 8''$.

This cabinet is made in two die-cast halves, hinged at the back. When shut, perfect screening is afforded, but instant accessibility to the inside components is obtained when the cabinet is open.

The two halves meet together at the side with an overlapping joint and a spring clip is fitted to keep the cabinet closed.

It is finished brown with a glossy stoved paint inside and a smart brown crystalline finish outside. Small rubber feet are fitted to the bottom.

CAT. No. 975. Plain undrilled cabinet.

Code DICIP. PRICE 27/6

WELDED STEEL.

The No. 1061 cabinet is rigidly and strongly built in black crinkle finished steel. It has a hinged lid, and holes in the back allow entry of connecting leads. Size, $8\frac{1}{2}''$ wide \times $6''$ deep \times $7''$ high.

CAT. No. 1061. Code STECL. PRICE 9/6

Plain Undrilled Metal Panel.

No. 1118, 1/9 Extra.

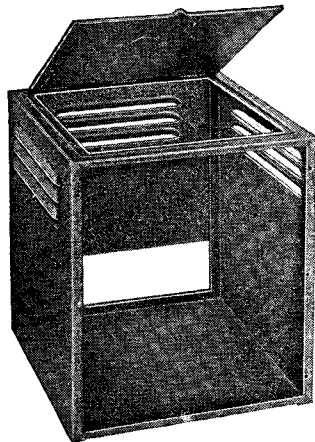
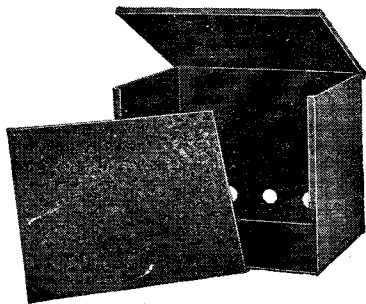

A very smart cabinet for the home constructor rigidly and strongly built and finished in a bright ripple stoved black finish. The lid is hinged and the cabinet has ventilating louvers at the back and sides. A plain undrilled panel is supplied and the baseboard should be fastened to this. The whole assembly pushing in from the front. A gap in the back of the small cabinet allows for connections. Made in two sizes.

CAT. No. 1033. Code STECA. PRICE 10/6

Size, $8\frac{1}{2}''$ wide \times $9\frac{1}{2}''$ back to front \times $9\frac{3}{8}''$ high.

Spare Panel if required. No. 1123, 1/9

CAT. No. 1034. Code STECO. PRICE 18/6

Size, $17''$ wide \times $9\frac{1}{2}''$ back to front \times $9\frac{3}{8}''$ high.

Spare Panel if required. No. 1132, 3/6

